

# P2X\*M

## MANIFOLDS

### FOR ISO 4401-03 (CETOP 03)

### VALVES WITH PORTS ON REAR

#### SERIES 10

- The P2X\*M series of manifolds is designed for connection in parallel of two or more ISO 4401-03 (CETOP 03) valves.
- The monobloc design enables the simple creation of circuits without the use of pipes and fittings, thereby reducing overall dimensions to a minimum.
- Subplates are arranged for the installation of a pressure control valve with cartridge.
- Each section is fitted with work ports A and B positioned on the rear of the subplate.
- Subplates are fitted with additional rear ports P and T.
- Subplates are made of cast iron.

**p max 350 bar**  
**Q max 100 l/min**

#### TECHNICAL SPECIFICATIONS

Maximum operating pressure - ports P - A - B - port T	bar	350 140
Maximum flow	l/min	100
Port dimensions: P - pressure T - drainage B - users A - drainage	BSP	1/2"
Ambient temperature range	°C	-20 / +50
Fluid temperature range	°C	-20 / +80
Fluid viscosity range	cSt	10 ÷ 400
Fluid contamination degree	cSt	25
Recommended viscosity	According to ISO 4406:1999 class 20/18/15	

#### 1 - IDENTIFICATION CODE

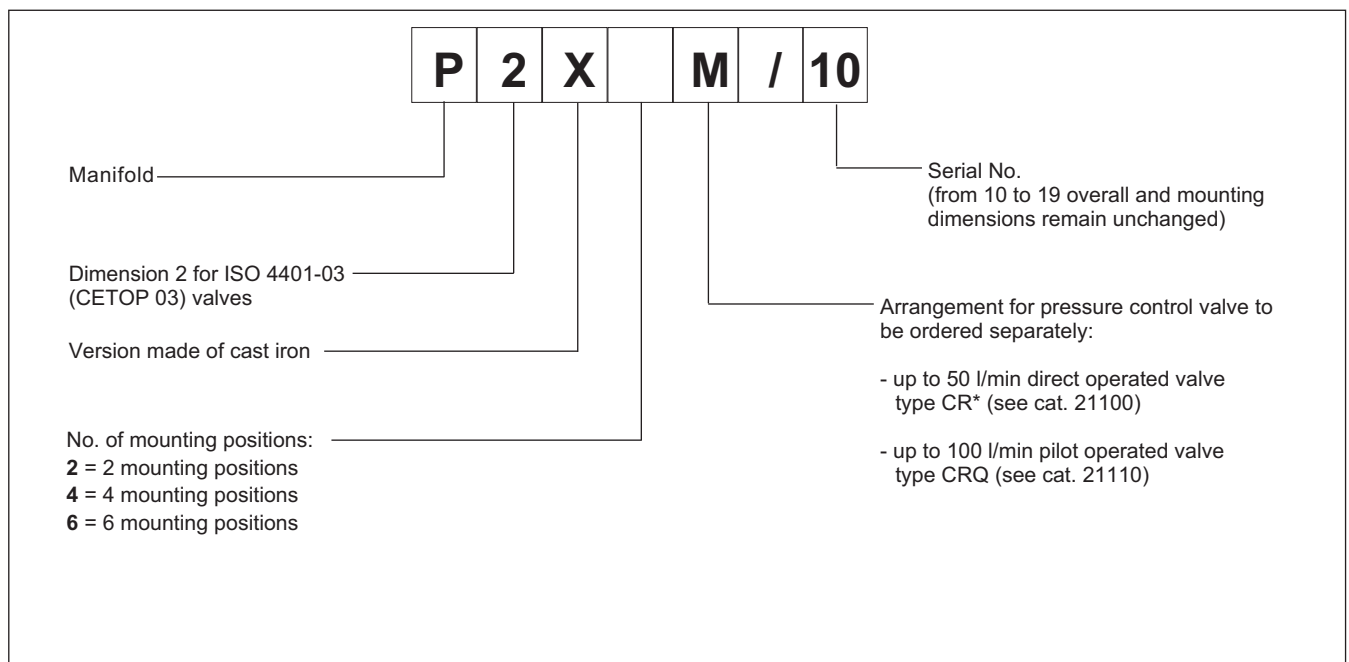



## 2 - OVERALL AND MOUNTING DIMENSIONS

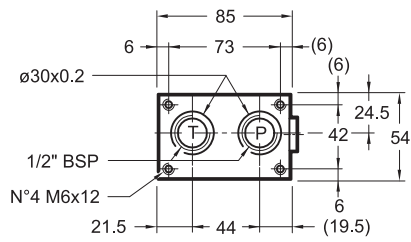

Es. Subplate with 6 mounting positions and pressure control valve type CR\*/21

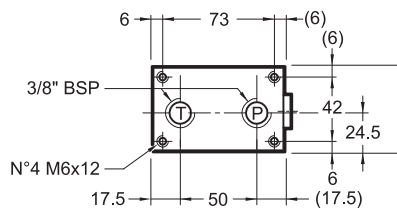
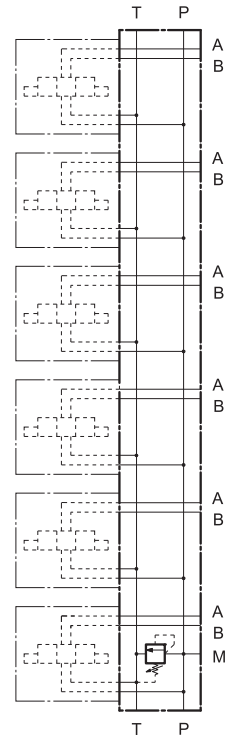
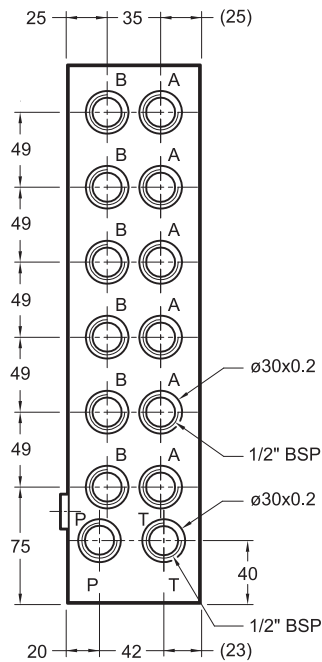
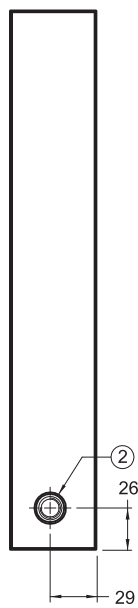
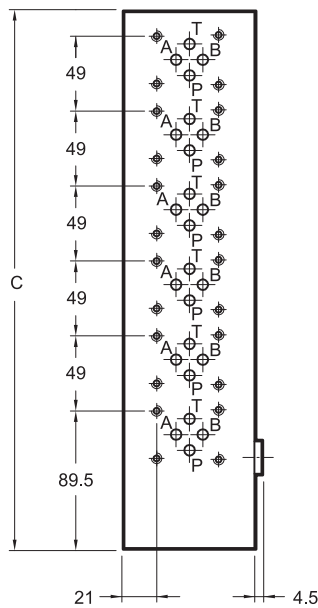
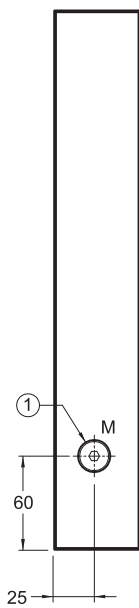

dimensions in mm

Manifold	No. of valves mounting positions	C
P2X2M/10	2	150
P2X4M/10	4	250
P2X6M/10	6	350

1	Pressure gauge port 1/4" BSP plugged
2	Arranged for the installation of a pressure control valve (to be ordered separately - see par. 1)



**DIPLOMATICO OLEODINAMICA S.p.A.**  
 20015 PARABIAGO (MI) • Via M. Re Depaolini 24  
 Tel. +39 0331.895.111  
 Fax +39 0331.895.339  
 www.diplomatic.com • e-mail: sales.exp@diplomatic.com